

DATA SHEET

ZCABLES: ZFTDSRD0850A1XX

25.78Gb/s SFP+ Short Wavelength (850nm) Transceiver

ZFTDSRD0850A1XX Overview

ZCables' ZFTDSRD0850A1XX optical transceivers are based on 25G Ethernet IEEE 802.3 standard. They are compliant with FC-PI-6、SFF-8402、SFF-8419、SFF-8432 and SFF-8472, providing a fast and reliable interface for 25G Ethernet applications. The product implements the digital diagnostics required by the SFF-8472 via a 2-wire serial bus.

Product Features

- Operating data rate support 21Gbps to 25.83Gbps
- Compliant with IEEE 802.3
- Compliant with FC-PI-6
- Compliant with SFF-8402
- Compliant with SFF-8419
- Compliant with SFF-8432
- Compliant with SFF-8472
- Clock data recovery on transmit and receive channels CDR
- Hot-pluggable SFP+ footprint
- 850nm VCSEL laser transmitter
- Duplex LC connector
- Built-in digital diagnostic functions
- Up to 70m on OM3 MMF and 100m on OM4 MMF
- Single power supply 3.3V
- RoHS-6 Compliant
- Operating temperature range: 0°C to 70°C(Case temperature)



Applications

- 25GBASE-SR Ethernet
- CPRI and eCPRI Wireless Networks

Ordering Information

Part Number	Description	Color on Clasp
ZFTDSRD0850A1xx	25GBASE-SR SFP28 850nm LC Connectors, up to 70m(OM3) or 100m(OM4) on MMF, with DOMfunction	Black
For More Information: ZCables https://zcables.com support.tw@zcables.com		

General Specifications

Parameter	Symbol	Min	Typ	Max	Unit	Remarks
Operating Temperature	T _C	0		70	°C	1
Storage Temperature	T _{STO}	-40		85	°C	2
Supply Current	I _{CC}		145	290	mA	3
Input Voltage	V _{CC}	3.15	3.3	3.46	V	
Maximum Voltage	V _{MAX}	-0.5		4	V	3

Notes:

1. Case temperature
2. Ambient temperature
3. For electrical power interface

Link Distances

Parameter	Symbol	Min	Typ	Max	Unit	Remarks
Data rate	DR		25.78		Gbps	1
Bit error rate	BER			5x10 ⁻⁵		2
OM3 multimode fiber (bandwidth 2000MHz*km)	L			70	M	3
OM4 multimode fiber (bandwidth 4700MHz*km)	L			100	M	3

Notes:

1. IEEE802.3
2. Measured with data rate at 25.78Gbps, PRBS 2³¹-1
3. This module requires RS-FEC on the host ports for operation at 25G

Optical – Characteristics – Transmitter

$V_{CC}=3.15V$ to $3.46V$, $T_C=0^{\circ}C$ to $70^{\circ}C$

Parameter	Symbol	Min	Typ	Max	Unit	Remarks
Output Optical Power	P_{TX}	-8.4		2.4	dBm	1
Optical Center Wavelength	λ_C	840	850	860	nm	
Optical Modulation Amplitude	OMA	-6.4		3	dBm	
Extinction Ratio	ER	2			dB	
Spectral Width (RMS)	$\Delta\lambda$			0.6	nm	
Relative Intensity Noise	RIN			-128	dB/Hz	
Transmitter Dispersion Penalty	TDP			4.3	dB	

Notes:

1. Average

Optical – Characteristics – Receiver

$V_{CC}=3.15V$ to $3.46V$, $T_C=0^{\circ}C$ to $70^{\circ}C$

Parameter	Symbol	Min	Typ	Max	Unit	Remarks
Optical Center Wavelength	λ_C	840	850	860	nm	
Optical Input Power@25.78Gbps	P_{RX}	-10.3		3	dBm	1
Optical Return Loss	ORL	12			dB	
LOS Assert	LOS_A	-30			dBm	
LOS De-Assert	LOS_D			-13	dBm	
LOS Hysteresis	LOS_H	0.5			dB	

Notes:

1. Average

Electrical – Characteristics – Transmitter

$V_{CC}=3.15V$ to $3.46V$, $T_C=0^{\circ}C$ to $70^{\circ}C$

Parameter	Symbol	Min	Typ	Max	Unit	Remarks
Input differential impedance	R_{IN}		100		Ω	
Differential data input swing	V_{IN_PP}	180		1600	mV	
Transmit Disable Voltage	V_D	2		V_{CC}	V	
Transmit Enable Voltage	V_{EN}	V_{EE}		$V_{EE}+0.8$	V	

Electrical – Characteristics – Receiver

$V_{CC}=3.15V$ to $3.46V$, $T_C=0^{\circ}C$ to $70^{\circ}C$

Parameter	Symbol	Min	Typ	Max	Unit	Remarks
Differential output swing	V_{OUT_PP}	370	600	850	mV	
LOS Assert	LOS_A	2		V_{CC_HOST}	V	
LOS De-Assert	LOS_D	V_{EE}		$V_{EE}+0.5$	V	

Digital Diagnostic Functions

The ZFTDSRD0850A1XX supports the 2-wire serial communication protocol defined in SFF-8472, which accesses digital diagnostic information via a 2-wire interface at address 0xA2. Digital diagnostics default to internal calibration, and the internal micro-control unit accesses device operating parameters such as transceiver temperature, laser bias current, transmitted optical power, received optical power, and transceiver supply voltage in real time. The module implements the alarm function of the SFF-8472.

Block-Diagram-of-Transceiver

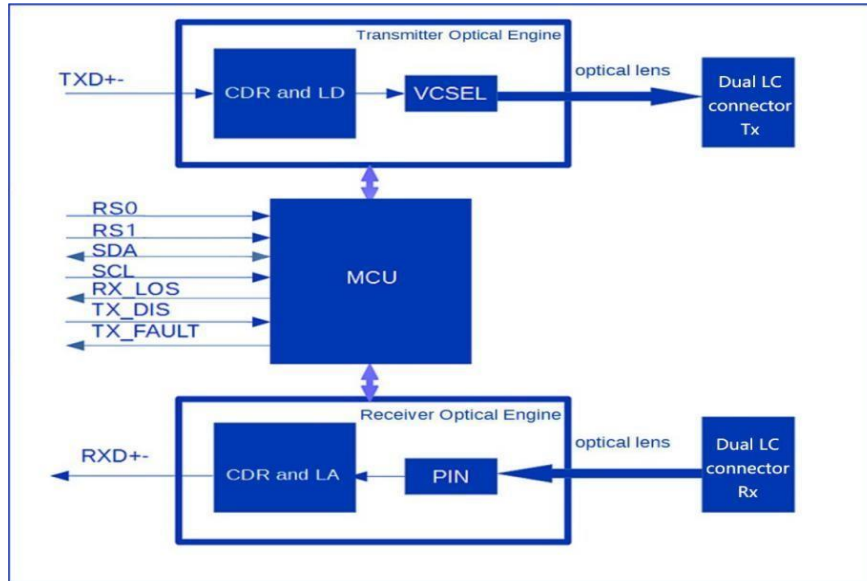

Functions Description

ZCables' ZFTDSRD0850A1XX module is manufactured using the advanced COB (Chip on Board) process. It consists of a microcontroller, a transmitter optical engine and a receiver optical engine. The module has built-in clock and data recovery functions. The operating rate range of the built-in CDR for the transmitter and receiver is: 21-25.83Gbps. If you need other speed range versions or dual rate range versions, you can contact us for special customization. Our company can also provide customized of vulcanization resistant hardware.

Microcontrollers communicate with the host via a 2-wire serial communication interface, providing module control, status reporting and monitoring (DOM), which is SFF-8472 compliant.

The transmitter optical engine includes a transmitter clock recovery circuit (CDR) and a laser driver circuit (LD), a VCSEL laser, and a detection photodiode (MPD). The high-speed differential electrical signal output by the host is recovered by the CDR, sent to the laser driver for amplification, and the VCSEL laser is driven to generate an optical signal, which is coupled to the optical fiber through the optical lens. The light engine integrates a photodiode for detection for output optical power detection, and the laser driver uses an automatic optical power control loop to ensure the stability of the transmitted optical power.

The receiving end light engine includes a photodiode (PIN), a signal amplifier (TIA/LA) and a receiving end clock data recovery circuit (CDR). The optical signal in the optical fiber is coupled to the receiving photodiode (PIN) through the optical lens to be converted into The photo-generated current, the photo-generated current signal is amplified by the amplifier, sent to the CDR circuit and recovered from the clock and data signals, and finally output to the host as a high-speed differential signal. The microcontroller reads the light intensity received by the photodiode and reports the loss of the received signal if it falls below the set threshold.

Dimensions

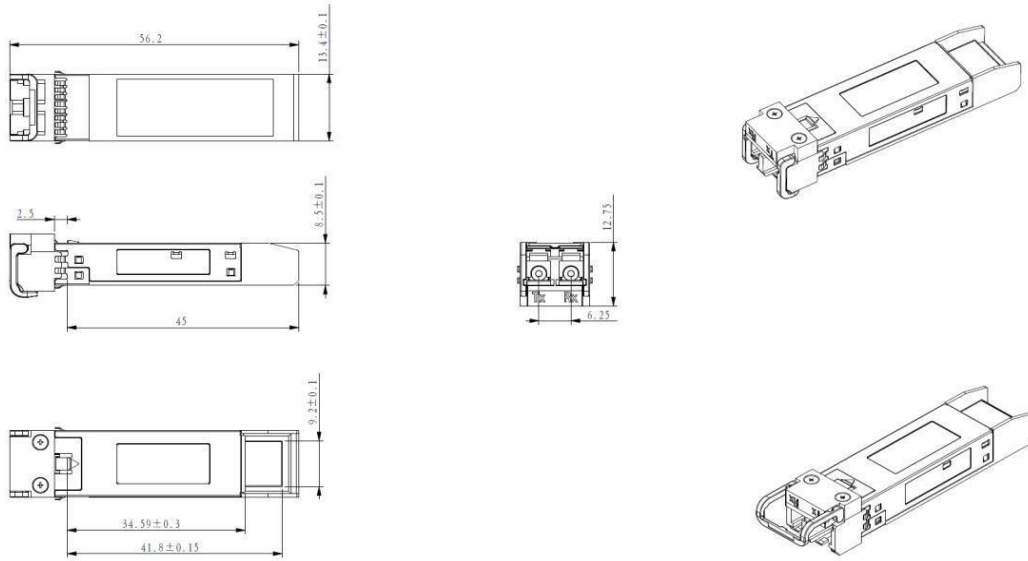

ALL DIMENSIONS ARE $\pm 0.2\text{mm}$ UNLESS OTHERWISE SPECIFIED
UNIT: mm

Electrical Pad Layout

Top View Of Board

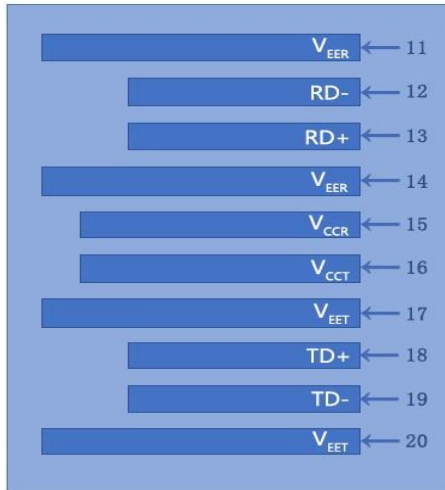

Bottom View Of Board

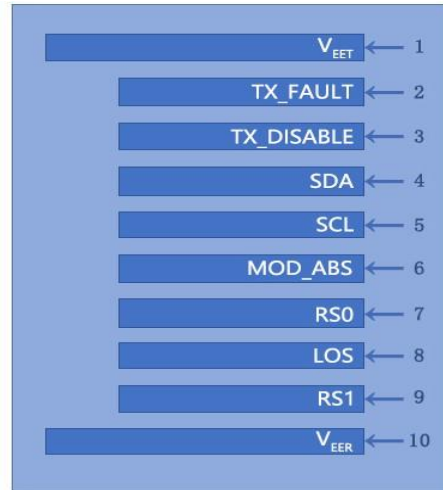

TOP

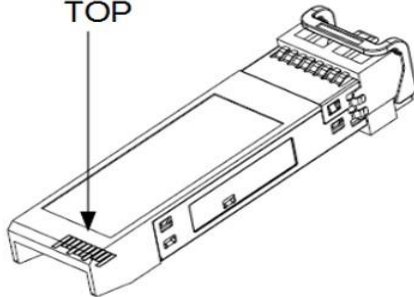

Bottom

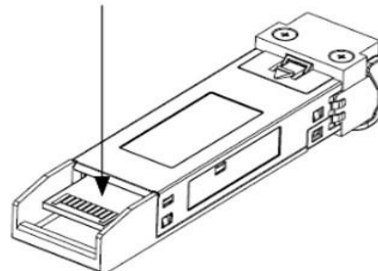

Typical Eye Diagram

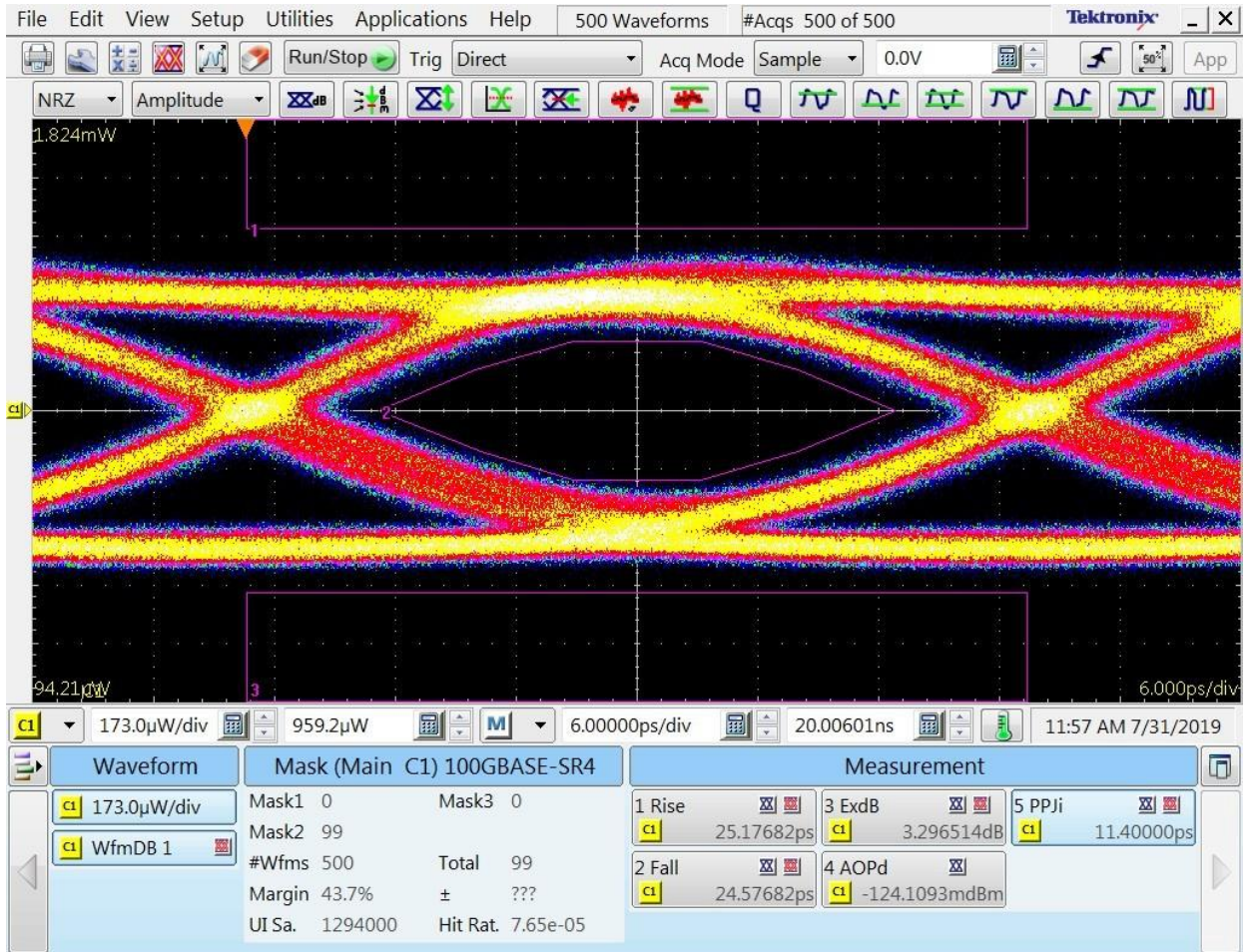

Pin Assignment

PIN #	Symbol	Description	Remarks
1	V _{EET}	Transmitter ground (common with receiver ground)	1
2	TX_FAULT	Transmitter Fault	
3	TX_DISABLE	Transmitter Disable. Laser output disabled on high or open	2
4	SDA	2-wire Serial Interface Data Line	3
5	SCL	2-wire Serial Interface Clock Line	3
6	MOD_ABS	Module Absent. Grounded within the module	3
7	RS0	No connection required	
8	LOS	Loss of Signal indication. Logic 0 indicates normal operation	4
9	RS1	No connection required	1
10	V _{EER}	Receiver ground (common with transmitter ground)	1
11	V _{EER}	Receiver ground (common with transmitter ground)	1
12	RD-	Receiver Inverted DATA out. AC coupled	
13	RD+	Receiver Non-inverted DATA out. AC coupled	
14	V _{EER}	Receiver ground (common with transmitter ground)	1
15	V _{CCR}	Receiver power supply	
16	V _{CCT}	Transmitter power supply	
17	V _{EET}	Transmitter ground (common with receiver ground)	1
18	TD+	Transmitter Non-Inverted DATA in. AC coupled	
19	TD-	Transmitter Inverted DATA in. AC coupled	
20	V _{EET}	Transmitter ground (common with receiver ground)	1

Notes:

1. Circuit ground is isolated from chassis ground
2. Disabled: T_{DIS}>2V or open, Enabled: T_{DIS}<0.8V
3. Should Be pulled up with 4.7k - 10k ohm on host board to a voltage between 2V and 3.6V
4. LOS is open collector output