

Push-Pull Circular Connectors



Application	
Motors	Power
Electronics	Mechanical
Medical Equipment	MRT
Automobiles	Electric Vehicles
Communication Equipment	Military Application

1P Plastic series

JPC offers diversified plastic and medical connectors ideal for medical equipment. Features including quick mating/unmating, keying, color-coding, chemical resist, vibration resist, enduring high-temperature, and pressure. From patient monitoring devices to disposable surgical ablation catheters, our connectors offer medical grade push-pull self latching connector in plastic, metal, and even waterproof IP68 connector features. Furthermore, our customization service can offer you proper features to meet your medical connector needs.

Technical Data

Part Number	PZACF1PXD19041
For cable ø	2.7 to 6.5 mm
Current rating	2 to 10A
Dielectric withstanding voltage	0.6 to 1.2kV rms
Insulation resistance	10 ¹² Ω
PSU/PEI working temp	- 50°C~150°C/- 50°C~170°C
Durability: gt	2,000 cycles
Average/Cable retention force	50N/50~150N
Connector type	Straight plug, Free socket, Fixed socket
NO. of contacts	2 to 14 Pin

Product Features

Push-Pull self-latching

Quick and easy mating and de-mating

FDA approved biocompatible materials (PSU or PEI)

Electrical Safety (touch & scoop proof)

Multiple Key options (6 keyways)

Wide selection of colors for easy recognition (Black, White, Red, Yellow, Green, Blue,Grey)

Watertight and disposable connectors available





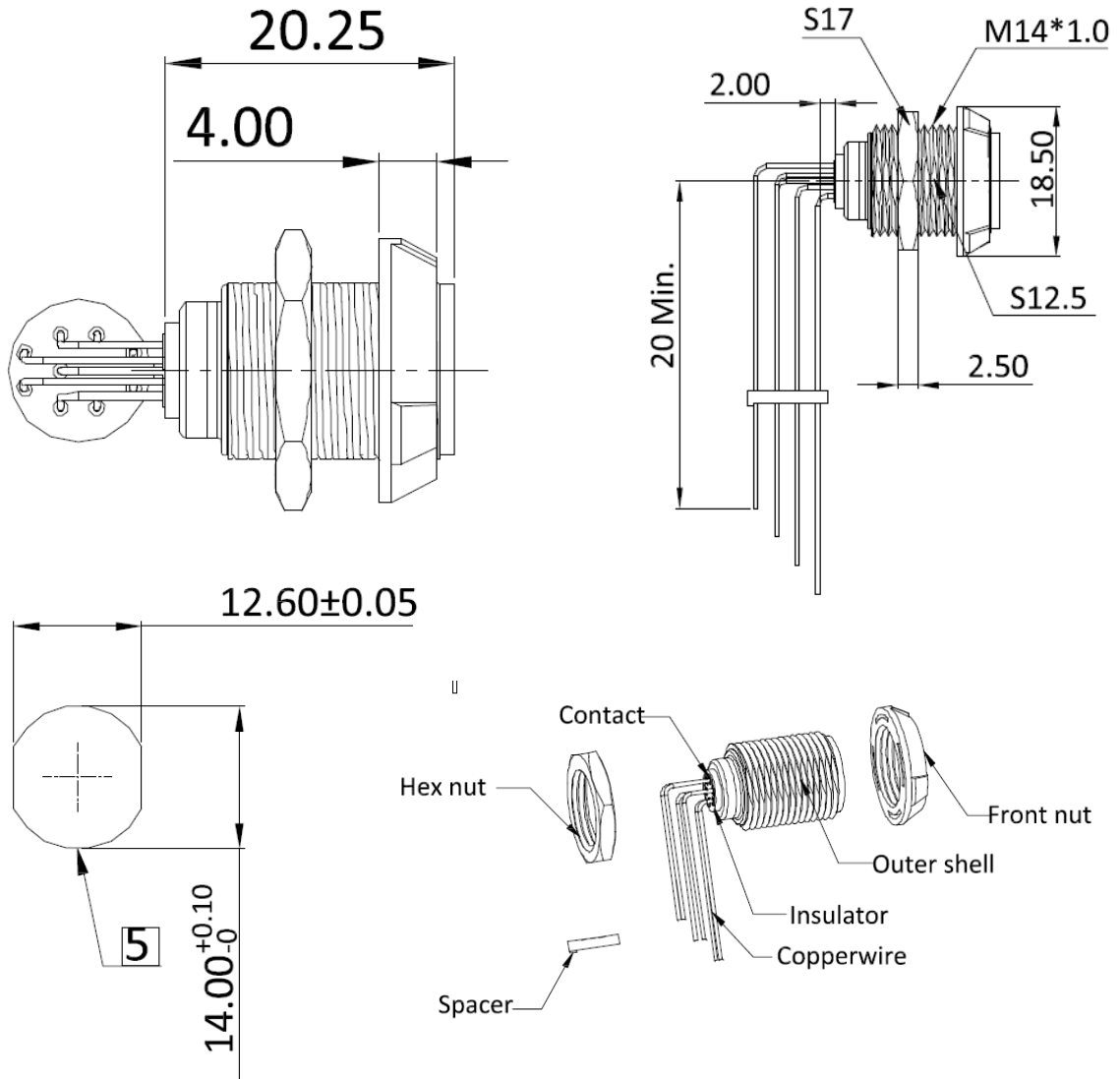





1P Plastic series

Interface Dimensions



1P Plastic series

Key Direction

2 Pin	
3 Pin	
4 Pin	
5 Pin	
6 Pin	
7 Pin	
8 Pin	
9 Pin	
10 Pin	
12 Pin	
14 Pin	