

THIS DRAWING AND THE DATA DISCLOSED HEREIN OR HEREWITH IS NOT TO BE REPRODUCED USED OR DISCLOSED IN WHOLE OR IN PART TO ANYONE WITHOUT THE PERMISSION OF JESS-LINK PRODUCTS CO.,LTD.(JPC)

CUSTOMER DRAWING
DRWC-XXXXXX

REV.	ECN NO.	DESCRIPTION	MDF'D	APP'D	DATE
01		INITIAL DESIGN	Philip	Richard	07/06/2023
02					
03					

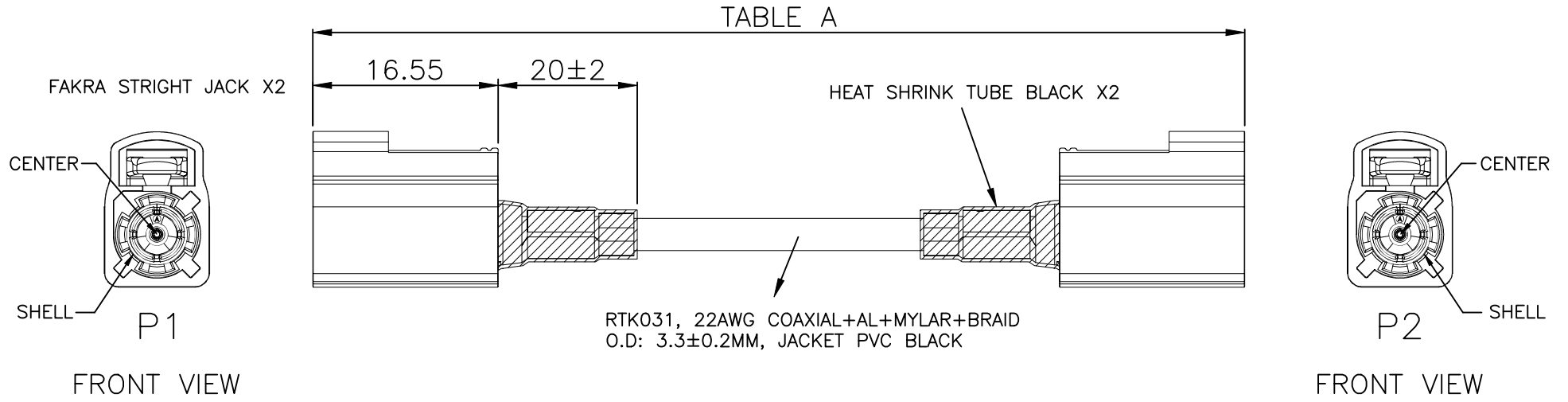

NOTES:

MATERIAL:
CONNECTOR: FAKRA STRIGHT JACK
MATERIAL: THERMOPLASTIC UL94V-0 30u" GOLD

ELECTRONIC:
IMPEDANCE: 50Ω

ENVIRONMENTAL:
OPERATING TEMPERATURE RANGE: -40°C TO 105°C

TESTING CONDITION:
CONDUCTIVE RESISTANCE 2 Ohm Max.
INSULATION RESISTANCE 20M Ohm Min
WITH DC200V DURING 0.05second.
100% OPEN, SHORT MISWITED TEST



TABLE A

JPC P/N	Length(mm)
PZBNHR010-0001	1000±20
PZBNHR020-0001	2000±30
PZBNHR050-0001	5000±50

REHS COMPLIANT	Unit:mm(inch)	PROJECTION 	ZCables.com		
	GENERAL TOLERANCES: (UNLESS SPECIFIED)	D.R. 07/06/2023 Philip			TITLE Fakra Stright Jack
	0 =±1 (0.039)	CH.K 07/06/2023 Philip	SCALE	SIZE	PART NO.
	0.0 =±.5 (0.02)	APV.D 07/06/2023 Richard	1:1	A4	PZBNHR0XX-0001
0.00 =±.3 (0.012)				REV. 01	
0.000=±.15(0.006)				SHEET 1 OF 2	
0 =± 2'					
0.0 =± 1"					

THIS DRAWING AND THE DATA DISCLOSED HEREIN OR HEREWITH IS NOT TO BE REPRODUCED USED OR DISCLOSED IN WHOLE OR IN PART TO ANYONE WITHOUT THE PERMISSION OF JESS-LINK PRODUCTS CO.,LTD.(JPC)

CUSTOMER DRAWING
DRWC-XXXXXX

REV.	ECN NO.	DESCRIPTION	MDF'D	APP'D	DATE
01		INITIAL DESIGN	Philip	Richard	07/06/2023
02					
03					

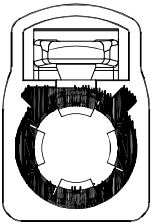
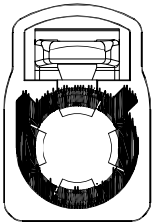
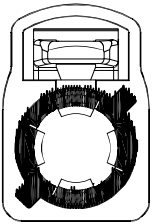
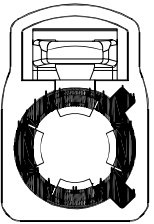
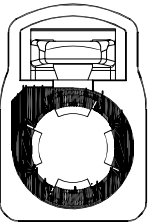
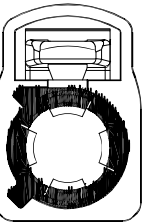
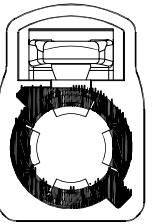
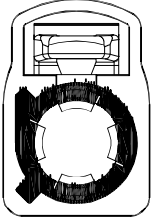
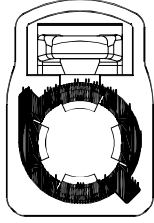
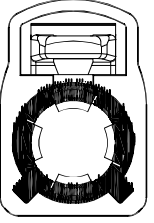
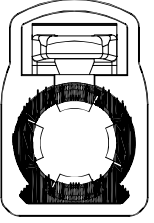
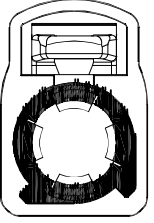
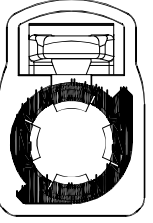
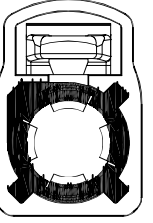
Coding	A	B	C	D	E	F	G
Plug							
Color	Black	White	Blue	Bordeaux Violet	Green	Brown	Grey
RAL	sim.9005	sim.9001	sim.5005	sim.4004	sim.6002	sim.8011	sim.7031
Coding	H	I	K	L	M	N	Z
Plug							
Color	Violet	Beige	Curry	Carmine Red	Patel Orange	Patel Green	Water Blue
RAL	sim.4003	sim.1001	sim.1027	sim.3002	sim.2003	sim.6019	sim.5021

REHS COMPLIANT	Unit:mm(inch)	PROJECTION 	ZCables.com		
	GENERAL TOLERANCES: (UNLESS SPECIFIED)	D.R. 07/06/2023 Philip	TITLE Fakra Stright Jack		
	0 =±1 (0.039) 0.0 =±.5 (0.02) 0.00 =±.3 (0.012) 0.000=±.15(0.006) 0° =± 2° 0.0° =± 1°	CH.K 07/06/2023 Philip	SCALE	SIZE	PART NO.
		APV.D 07/06/2023 Richard	1:1	A4	PZBNHR0XX-0001
				REV. 01	
				SHEET 2 OF 2	